

# EDGE TREATMENTS

for Solid Surface

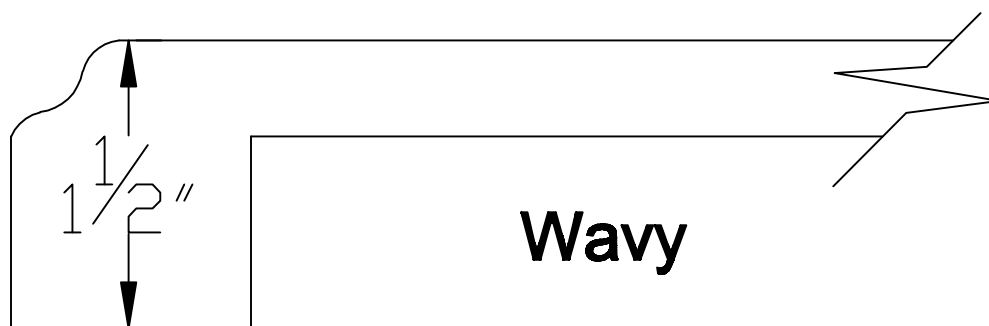
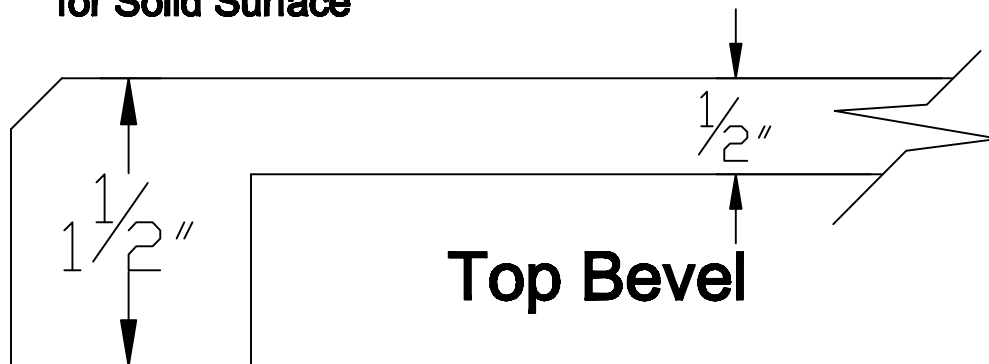

Edge treatments shown are for  $1\frac{1}{2}$ " kitchen tops. Vanity tops are normally 1" thick.  
For 1" edges, see Vanity Edge Treatments.

# EDGE TREATMENTS

for Solid Surface

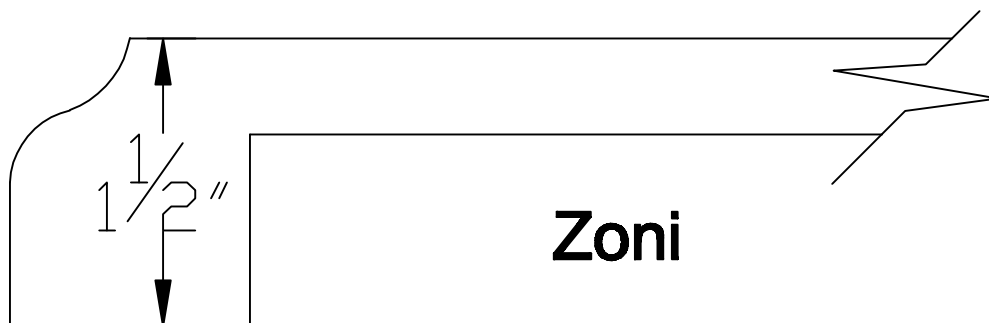
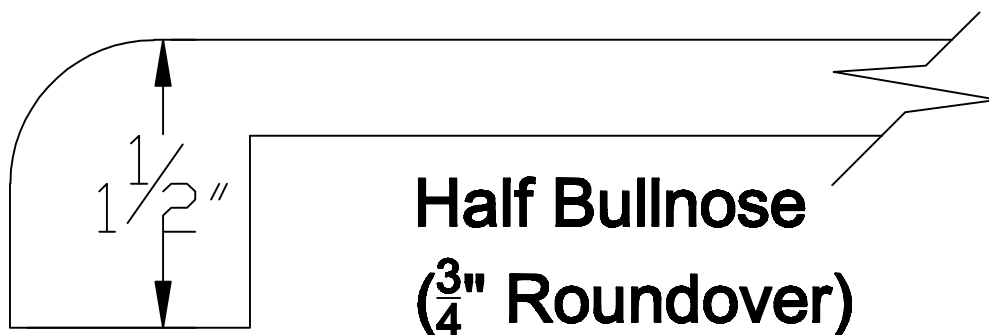
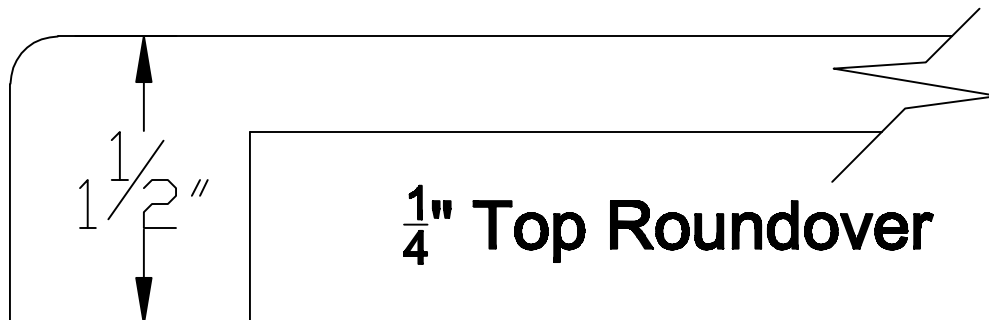
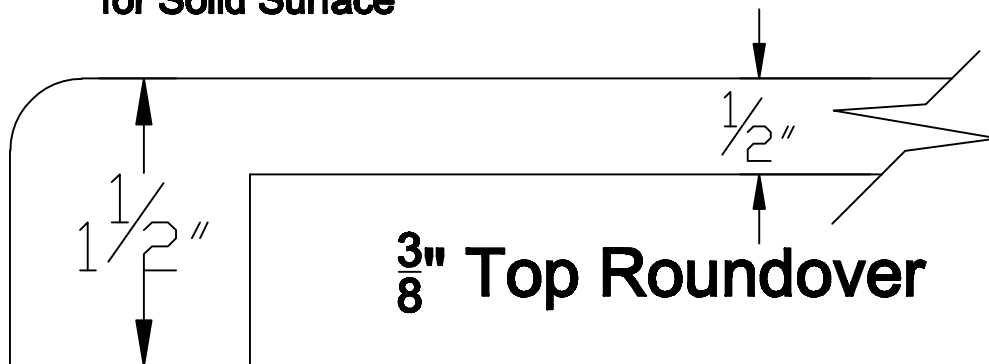

Edge treatments shown are for 1 1/2" kitchen tops. Vanity tops are normally 1" thick.  
For 1" edges, see Vanity Edge Treatments.

# PREMIUM EDGE TREATMENTS

for Solid Surface

Add 5%

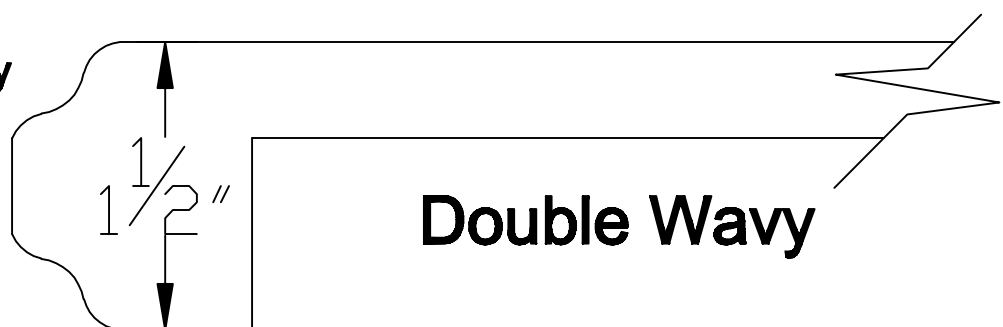
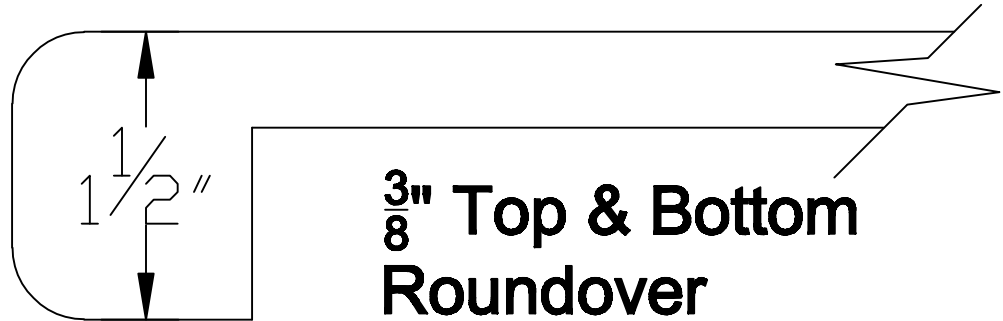
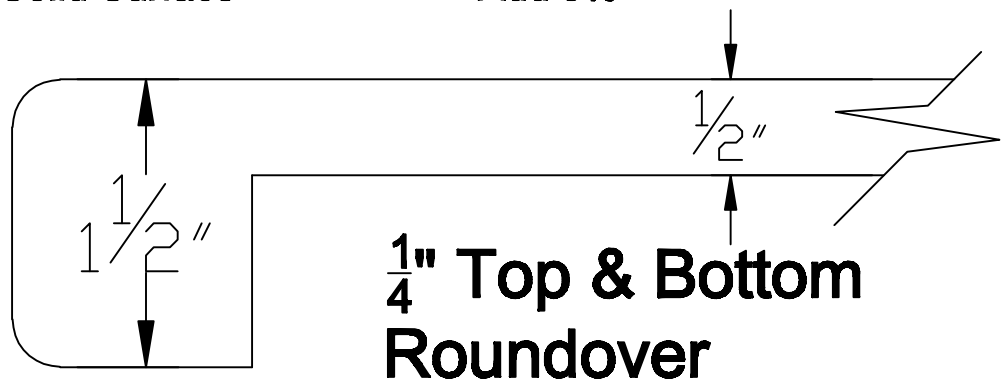

Edge treatments shown are for 1 1/2" kitchen tops. Vanity tops are normally 1" thick. For 1" edges, see Vanity Edge Treatments.

# VANITY EDGE TREATMENTS for Solid Surface

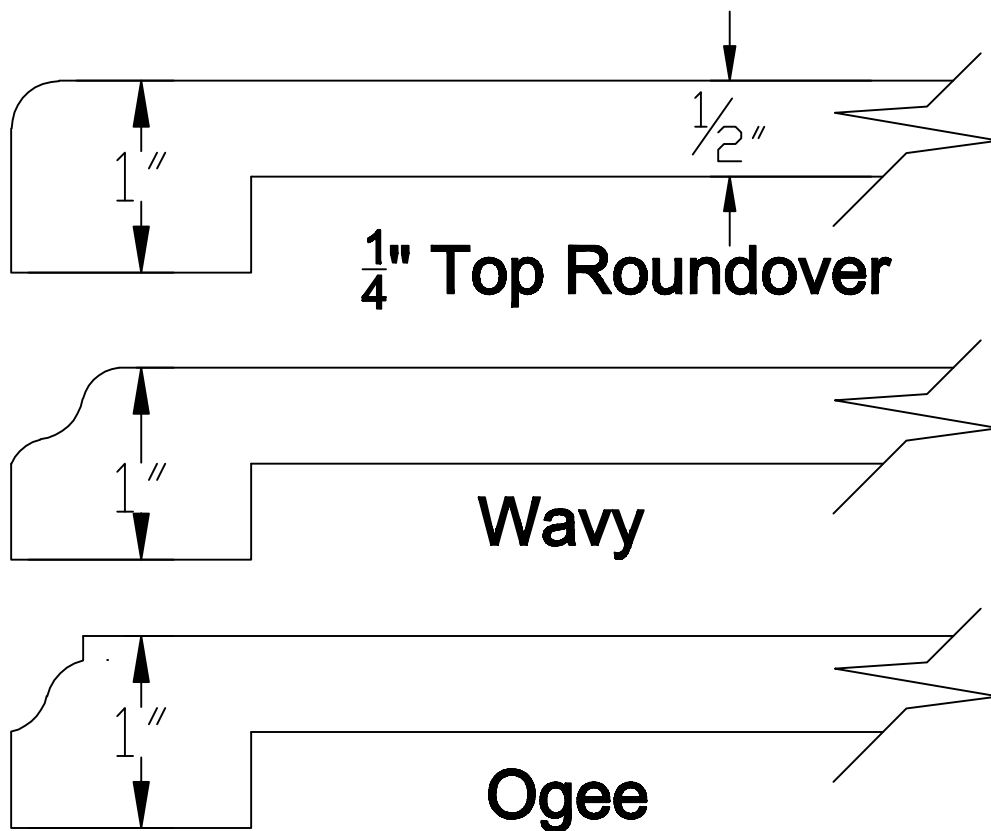

Edge treatments shown are for 1" vanity tops.  
Kitchen tops are normally 1 1/2" thick.  
For 1 1/2" edges, see Standard Edge Treatments.

# EDGE TREATMENTS

for Stone

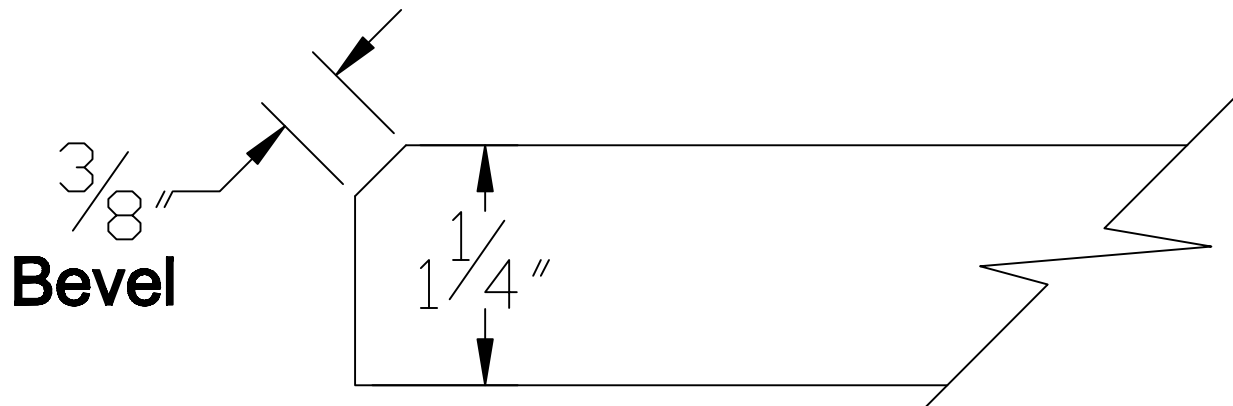
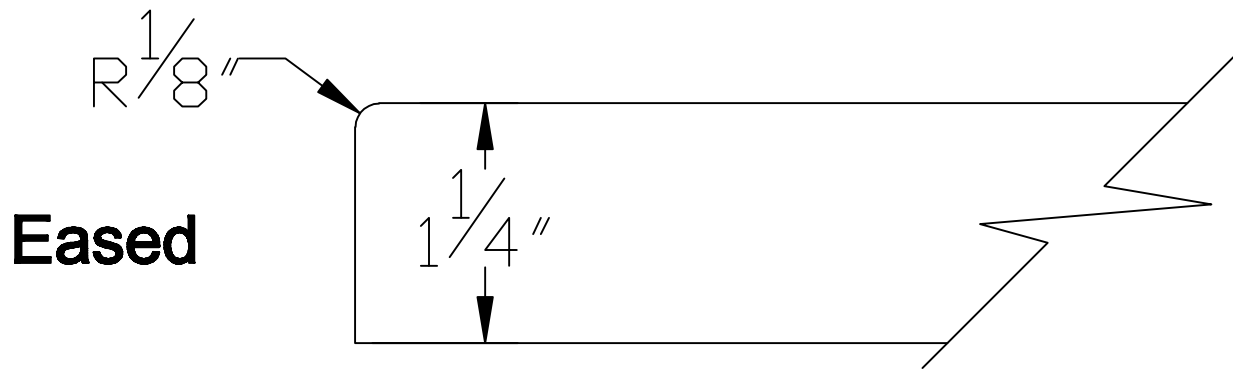
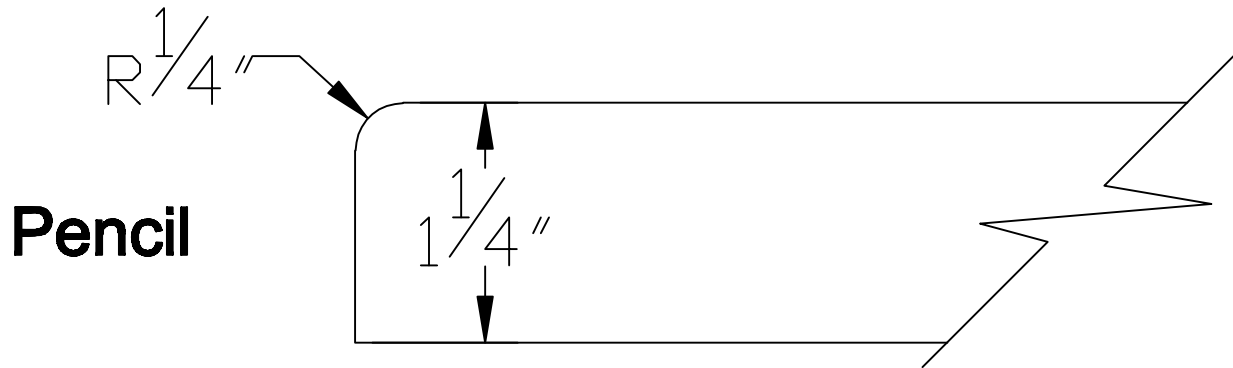

**PREMIUM**  
**EDGE TREATMENTS**  
for Stone

**DuPont**

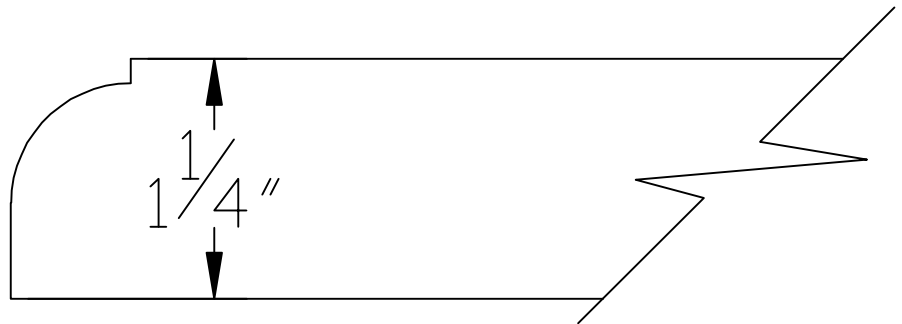

**Half Bullnose**

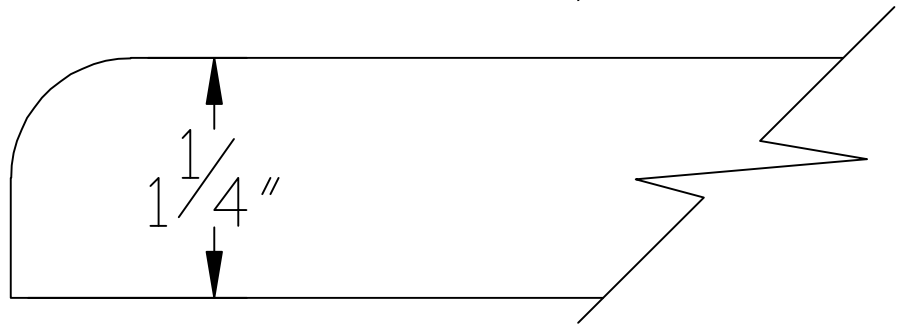

**Full Bullnose**

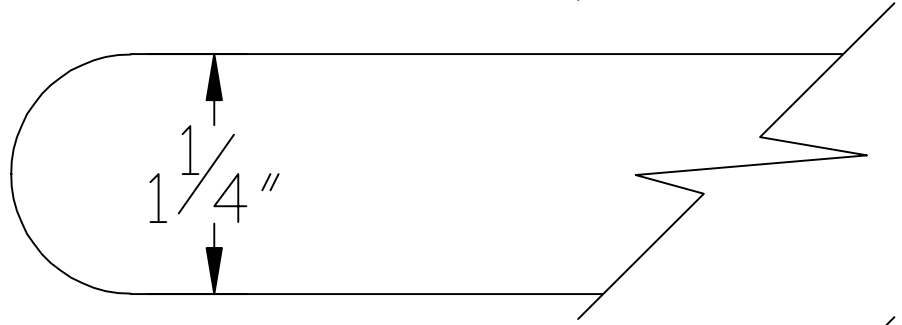

**Ogee**

